

Jacto® MODEL HD300 BACKPACK SPRAYER ILLUSTRATED PARTS MANUAL

Congratulations!

You're the owner of a heavy-duty Jacto HD300 backpack sprayer, engineered using the latest technology and manufactured with advanced materials to provide long-life durability while delivering unsurpassed spraying performance.

Jacto backpack sprayers are designed and warranted for use with agrochemicals. This is a serious spraying machine designed for smaller areas of application, yet it's easy to operate and simple to maintain.

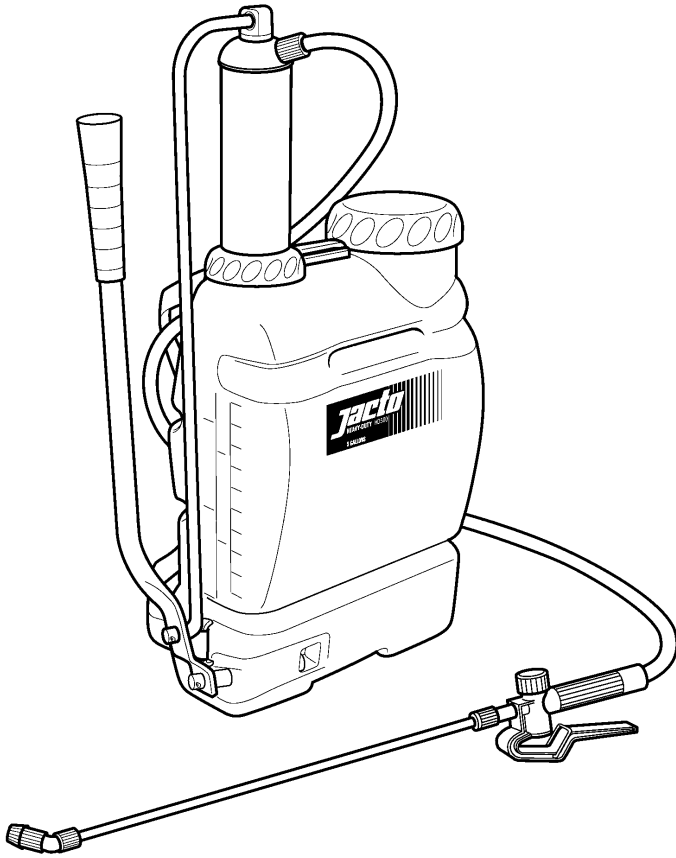

Features Of Your New Jacto Sprayer

- High-efficiency piston pump for minimum operator effort
- Viton® seals are chemical resistant for longer life
- In-tank pump eliminates external pump leaks during or after operation
- Easy-to-adjust padded shoulder straps for maximum comfort
- Accurate filling scale is easy to read, measures liters and gallons
- Anatomical shape fits the operator's back for maximum comfort
- Extra-large tank fill opening for faster filling, reduced chance of spills
- Dry weight is just 9.7 pounds
- Easy maintenance and cleaning
- Convenient carrying handle built-in to tank
- Operating pressure—15-65psi
- UV resistant tank with 3.0 gallon usable capacity
- Internal mechanical agitator for constant mixing of tank solution
- Heavy-duty trigger valve is field serviceable
- Reinforced Nylon 4-chamber spray lance for maximum durability
- Measuring cup, field service kit and extra nozzles included at no extra charge
- One-year limited warranty

Limited Warranty

Jacto manufactures and distributes superior quality products to promote the highest customer satisfaction level possible. Jacto warrants these products to the original purchaser as follows:

Warranty Period

One (1) year from the purchase date by the original owner.

Warranty Application

Jacto warrants this product to be free from defects in materials and workmanship, under normal use and maintenance, subject to the periods, limitations, and exclusions listed below. Jacto will correct any defect in material or workmanship without charge for parts or labor at any authorized Jacto repair outlet during the covered warranty period.

To obtain warranty repair, present the defective product to your authorized Jacto outlet, along with all pertinent information, including proof of purchase, model and serial number, total hours of operation, and identified defect.

The replacement of assemblies such as pumps, control valves, engines, transmissions, hydraulic pistons, etc., shall only be performed if the defect cannot be repaired by replacing individual parts and/or components.

Warranty Exclusions and Limitations

Jacto assumes no responsibility for damages, loss or injury resulting from:

- Normal wear and tear.
- Parts considered as normal wear and tear items, such as, but not limited to: belts, filters, PTO Shafts, hoses, nozzles, batteries, tires, pistons, and pressure gauges.
- Hydraulic, lubricating oils and grease.
- Misuse, neglect, improper maintenance, cleaning or adjustments.
- Modifications to or removal of original component parts.
- Spare or replacement parts not conforming to manufacturer's specifications.
- Service by other than an authorized Jacto servicing outlet.
- Damages of any nature resulting from action of gases or chemicals used in the equipment.

Events beyond our control resulting in delays in performing services do not confer to the owner the right to indemnity or to extension of the warranty period.

This warranty is limited to the terms stated herein. Jacto disclaims all liability for incidental or consequential damages. Some states do not allow the exclusion of incidental or consequential damages, so these limitations may not apply. This warranty gives you specific legal rights and you may have other rights, which vary from state to state.

Jacto reserves the right to change the design or specification of any product without obligation to modify previously produced units.

For recording purposes, and so we can notify you regarding product updates, the product registration card must be completed, signed by the original purchaser, and returned to Jacto within 30 days of original purchase date. All product registration cards returned will be entered into a random drawing for a Jacto backpack sprayer.

JACTO HD300 BACKPACK SPRAYER ILLUSTRATED PARTS LIST

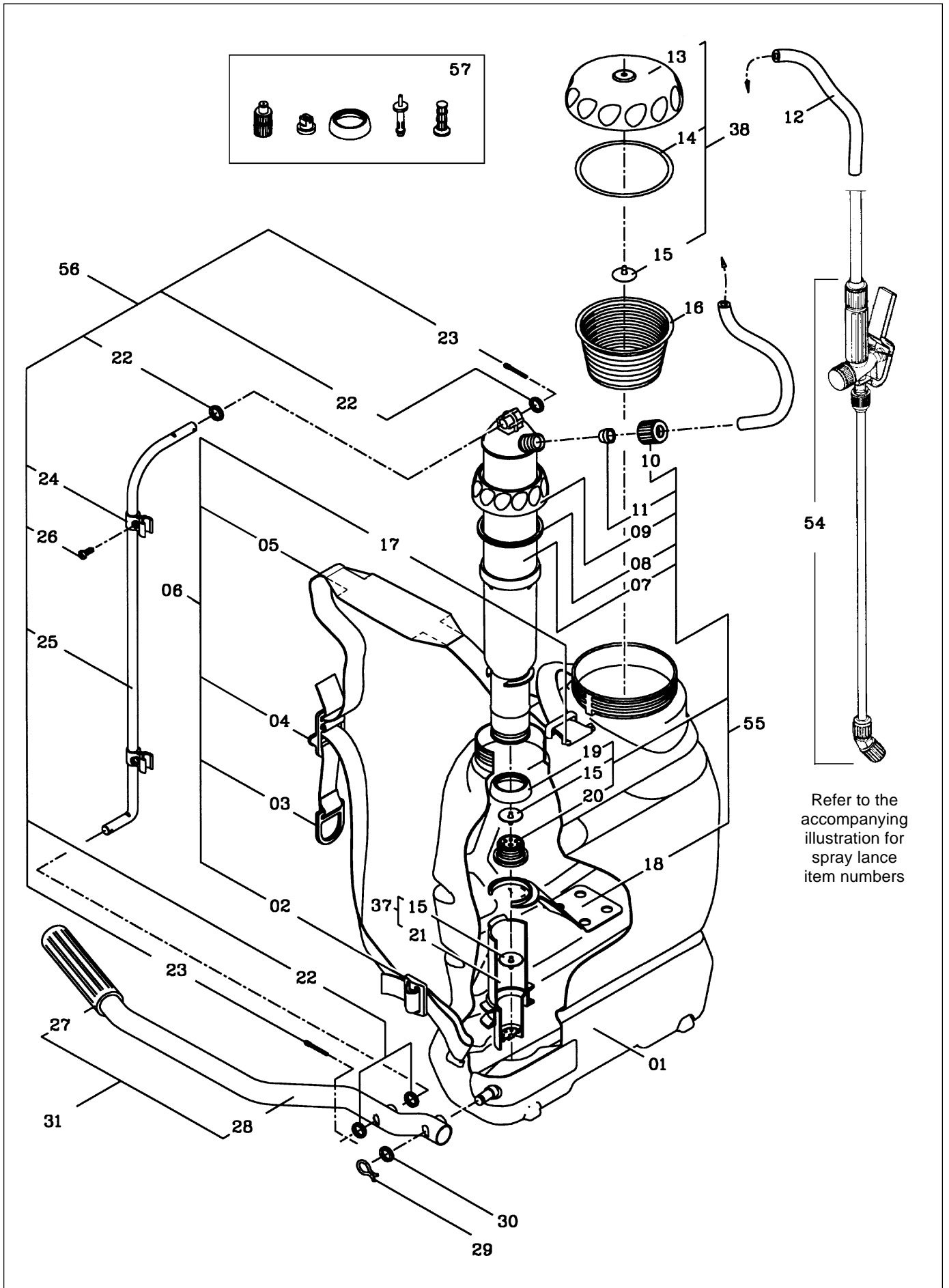



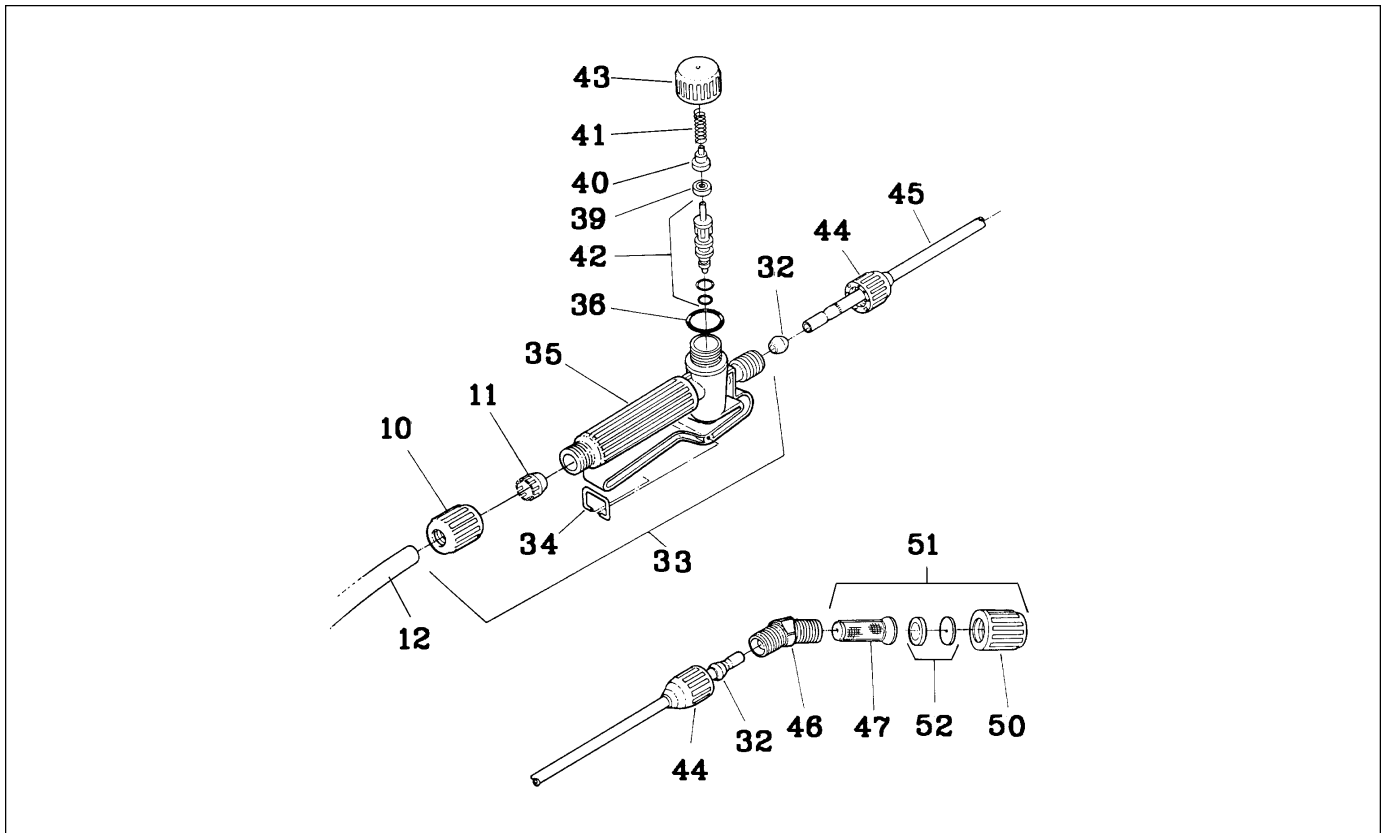





Tank Assembly

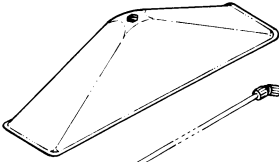
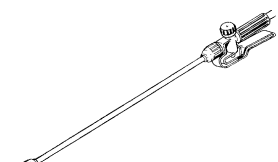
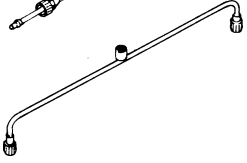
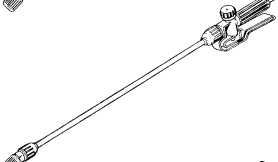
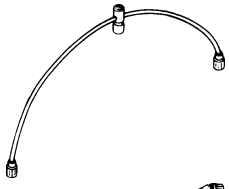
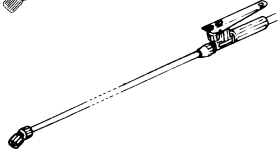
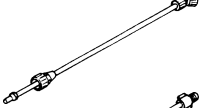
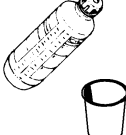
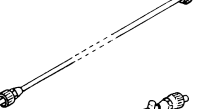



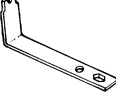

Lance Assembly

Item	Part No.	Description	Item	Part No.	Description
1	965186	Tank	30	965251	Flat washer
2	502757	Shoulder strap buckle	31	965277	Pump lever assembly (items 27 and 28)
3	965194	Lower strap assembly	32	909309	Wand ferrule
4	120691	Shoulder strap buckle	33	635847	Trigger valve assembly
5	965236	Upper strap assembly with shoulder pad	34	229773	Trigger valve lock
6	965376	Shoulder strap assembly	35	229757	Trigger valve body with handle
7	965319	Chamber body	36	229781	O-ring ORI-019
8	800577	Chamber packing ring	37	965226	Cylinder assembly (items 15 and 21)
9	965335	Packing ring nut	38	965210	Tank cap with seal and diaphragm
10	942193	Screw cap S-20	39	351536	Valve seat
11	661330	Hose ferrule	40	433730	Valve seat base
12	635326	Hose	41	904284	Compression spring
13	965343	Cap	42	229740	Trigger needle valve assembly
14	965350	O-ring cap seal ORI-245	43	229732	Trigger valve cap
15	560573	Diaphragm	44	915744	Screw cap
16	647123	Strainer	45	336263	Spray lance tube
17	965368	Shoulder strap retaining clip	46	560649	Spray lance nozzle elbow
18	214619	Mechanical agitator	47	730366	Nozzle filter (40 mesh)
19	568535	Plunger	48	210195	Swirl core-4 hole
20	214577	Plunger fastener	49	210088	Disk (Nozzle JD12)
21	965301	Cylinder	50	229724	Nozzle cap
22	609438	Flat washer	51	427062	Nozzle assembly JD12P
23	942904	Cotter pin 3/32 x 5/8"	52	217174	Sprayer nozzle JD 12P
24	838003	Spray lance holding clip	53	635854	Spray lance tube assembly with nozzle
25	965293	Pump lever connecting rod	54	229575	Spray lance assembly complete
26	942425	Screw 3.5 x 16 mm	55	965202	Chamber assembly complete
27	002683	Hand grip	56	965244	Pump lever connecting rod assembly
28	965285	Pump lever	57	838169	Repair kit (items 15, 19, and 20)
29	965269	Retaining clip			

Optional Accessories

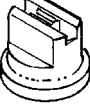
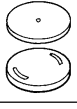
Part Number	Description	Part Number	Description
	558452 Spray hood for nonselective herbicides when spraying under windy conditions. For use with deflector-type nozzles. Complete with brass lance and Kematal flat fan nozzle 110-SF-015.		229575 Spray lance assembly (21.6"). Plastic handle, trigger valve and spray tube. 40 mesh stainless steel nozzle and trigger valve filters included. Fitted with JD-12P cone nozzle.
	902296 Brass spray boom (27.5") for use with agrochemicals and foliar fertilizers applied to row crops. Provides 40" coverage. JD-12P cone nozzles and 40 mesh stainless steel filter included.		878371 Spray lance assembly (21.6"). Plastic handle and trigger valve, and brass spray tube. 40 mesh stainless steel nozzle and trigger valve filters included. Fitted with JD-12P cone nozzle.
	907873 Flexible annealed copper boom fitted with three JD-12P cone nozzles. For use with agrochemicals and foliar fertilizers on row crops. Can be easily shaped as appropriate to provide proper coverage. 40 mesh stainless steel filter included.		725267 All brass spray lance assembly (21.6") for extra duty applications. Trigger valve and spray tube are brass. 40 mesh stainless steel nozzle and trigger valve filters included. Fitted with JD-12P cone nozzle.
	831107 Brass extension (11.8") complete with plastic fittings for extra reach. Attachable to original lance.		834309 Flow calibrator bottle. For accurate calibration of backpack sprayers to prevent waste and damage to the environment.
	728139 Brass extension (23.6") complete with plastic fittings for extra reach. Attachable to original lance.		837344 Calibrated measuring cup.
	100016 Brass extension (6.3") complete with two JD-12P cone nozzles for doubling output of agrochemicals and foliar fertilizers on perennials. 40 mesh stainless steel filter included.		838169 Standard Field Repair Kit for HD400 and HD300. Includes components to quickly rebuild trigger assembly and the piston cup. Contains: Piston cup, trigger valve needle, nozzle filter, adjustable cone nozzle, and deflector nozzle.
	336115 Brass Y nozzle for use on plants requiring heavy applications of fungicides. Complete with two JD-12P cone nozzles, 40 mesh stainless steel filter and plastic fittings.		761866 Standard Field Repair Kit for CD400 and CD550. Includes components to quickly rebuild trigger assembly and the piston cup. Contains: Piston cup, trigger valve needle, nozzle filter, adjustable cone nozzle, and deflector nozzle.
	565648 Plastic anti-drip valve for agrochemicals and foliar fertilizer application. Attaches to lance and compatible with any type of cone or flat fan nozzle.		834382 Standard X-15 Field Repair Kit. This Kit includes components to quickly rebuild the trigger assembly and the piston cup. Included are trigger valve needle assembly, trigger valve cap, 2 diaphragms and piston cup 45 x 12.
	452284 All purpose metal wrench for general maintenance of Jacto backpack sprayers.		

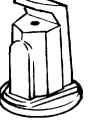
Jacto Optional Spray Nozzles

Nozzle Type	Part Number	Application	Pressure (psi)	Flow Rate (ml/min)	Flow Rate (gal/min)
	454215 80EF015 Kematal green	Herbicides	45	610	0.16
	454223 80EF02 Kematal yellow				
	454231 80EF03 Kematal blue				
	717942 JD-10A Stainless steel	Agrochemicals and foliar fertilizers	45	300	0.08
	217174 JD-12P Stainless steel				
	457317 HC-02 Kematal yellow		45	830	0.22
	457325 HC-04 Kematal red				
	457333 HC-05 Kematal brown				
	457390 DEF-04 Kematal red		15	950	0.25
	457408 DEF-05 Kematal brown				
	457416 DEF-06 Kematal gray				
	323725 Yellow		45	315	0.08
	015024 Red				
	325787 Blue				

Note: All Jacto sprayers come with the JD-12P nozzle installed as standard equipment.



JACTO INC.
11971 SW Herman Rd
Tualatin, OR 97062
1-800-JACTO-10